



# BILLY GOAT KV VACUUM

## Owner's Manual

KV600, KV650H, KV600FB, KV650HFB

### Accessories

<p><b>ON BOARD VACUUM HOSE KIT</b></p>	<p><b>OPTIONAL FELT/MESH DEBRIS BAG</b></p>	<p><b>NOZZLE WEAR GUARD KIT</b></p>	<p><b>CASTER KIT</b></p>	<p><b>SHREDDER KIT</b></p>	<p><b>KV LINER KIT</b></p>	<p><b>PROTECTIVE COVER</b></p>
<p>4" (102mm) x 7.5' (2.13m) For vacuuming in hard to reach areas.</p>	<p>For use in leaves and grass in dusty conditions.</p> <p><b><u>P/N 891126 FELT BAG</u></b> <b><u>P/N 891132 MESH BAG</u></b></p>	<p>For use in increasing the life of your nozzle by protecting it from damage</p>	<p>To allow for easy rolling and maneuverability on smooth surfaces.</p>	<p>Shreds leaves, reducing total volume.</p>	<p>Increases the life of the housing by protecting it from damage.</p>	<p>Protects the machine from the environment when not in use.</p>
<p><b>P/N 891125</b></p>		<p><b>P/N 891127</b></p>	<p><b>P/N 891128</b></p>	<p><b>P/N 891153</b></p>	<p><b>P/N 891134</b></p>	<p><b>P/N 891137</b></p>



**CONTENTS**

SPECIFICATIONS AND SOUND/ VIBRATION _____	3
INSTRUCTION LABELS _____	4
PACKING CHECKLIST _____	5
ASSEMBLY _____	6
OPERATION _____	7
MAINTENANCE AND TROUBLESHOOTING _____	8
ILLUSTRATED PARTS & PARTS LISTS _____	9-10

Go to <http://www.billygoat.com> for French-Canadian translations of the product manuals.

Visitez <http://www.billygoat.com> pour la version canadienne-française des manuels de produits



## KV Push Owner's Manual

### Specifications

	<b>KV600</b>	<b>KV650H</b>	<b>KV600FB</b>	<b>KV650HFB</b>
Engine: HP	6.0 (4.47 kW)	6.5 (4.85kW)	6.0 (4.47 kW)	6.5 (4.85kW)
Engine: Type	B&S Quantum	HONDA	B&S Quantum	HONDA
Engine: Model	112K020124E1	GSV190AN1L	112K020124E1	GSV190AN1L
Engine: Fuel Capacity	1.5 qt. (1.4 L)	1.6 qt. (1.5 L)	1.5 qt. (1.4 L)	1.6 qt. (1.5 L)
Engine: Oil Capacity	0.63 qt. (0.6 L)	0.58 qt (0.54L)	0.63 qt. (0.6 L)	0.58 qt (0.54L)
Total Unit Weight:	112# (50.8kg)	113# (51.3kg)	112# (50.8kg)	113# (51.3kg)
Overall Length	59" (1.5m)	59" (1.5m)	59" (1.5m)	59" (1.5m)
Overall Width	26.5" (0.7m)	26.5" (0.7m)	26.5" (0.7m)	26.5" (0.7m)
Overall Height	42.75" (1.1m)	42.75" (1.1m)	42.75" (1.1m)	42.75" (1.1m)
Max. operating slope	20°	20°	20°	20°
Sound in accordance with 2000/14/EEC standards	108 dBa	109 dBa	108 dBa	109 dBa
Sound at operator's ear	88 dBa	89 dBa	88 dBa	89 dBa
Vibration at operator position	0.5 g (4.95m/s <sup>2</sup> )	0.32 g (3.18m/s <sup>2</sup> )	0.5 g (4.95m/s <sup>2</sup> )	0.32 g (3.18m/s <sup>2</sup> )

### SOUND



SOUND LEVEL 97 dB(a) at Operator Position

Sound tests were conducted in accordance with 2000/14/EEC, and were performed on 7-25-07 under the conditions listed below.

Sound power level listed is the highest value for any model covered in this manual. Please refer to serial plate on the unit for the sound power level for your model.

General Conditions:	Sunny
Temperature:	88°F (31.1°C)
Wind Speed:	2 mph (3.8 kmh)
Wind Direction:	South South East
Humidity:	44%
Barometric Pressure:	30.07"Hg (764 mm Hg)

### VIBRATION DATA

VIBRATION LEVEL 0.5g (4.95m/s<sup>2</sup>)

Vibration levels at the operator's handles were measured in the vertical, lateral and longitudinal directions using calibrated vibration test equipment. Tests were performed on 12-20-2007 under the conditions listed below.

General Conditions:	Sunny
Temperature:	47.5°F (8.6°C)
Wind Speed:	3 mph (4.8kph)
Wind Direction:	West
Humidity:	87%
Barometric Pressure:	29.98 Hg (101.5kpa)

## INSTRUCTION LABELS

The labels shown below were installed on your BILLY GOAT® KV Vacuum. If any labels are damaged or missing, replace them before operating this equipment. Item numbers from the Illustrated Parts List and part numbers are provided for convenience in ordering replacement labels. The correct position for each label may be determined by referring to the Figure and Item numbers shown.



**LABEL DANGER KEEP HANDS AND FEET AWAY**  
ITEM #18 P/N 400424



**LABEL EAR EYE BREATHING ITEM #20**  
P/N 890254



**DANGER FLYING DEBRIS**  
ITEM # 19 P/N 810736



**LABEL READ MANUAL**  
ITEM #17 P/N 890301



**LABEL EXPLOSIVE FUEL**  
ITEM # 16 P/N 400268



**LABEL SPARK ARRESTOR**  
P/N 100252

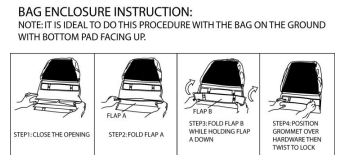

**DEBRIS BAG FOLDING LABEL**  
LOCATED ON BAG

## ENGINE LABELS

### HONDA

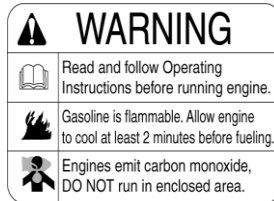
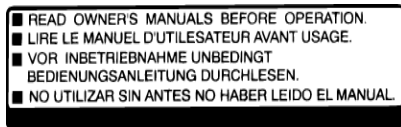

### BRIGGS & STRATTON

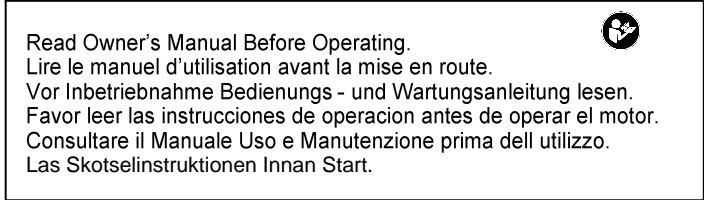

## ENGINE CONTROLS



Honda Throttle Control



Briggs Throttle Control



**PACKING CHECKLIST**

Your Billy Goat KV Vacuum is shipped from the factory in one carton, completely assembled except for the upper handle, debris bag, and bag quick disconnect.



**READ** all safety instructions before assembling unit.

**TAKE CAUTION** when removing the unit from the box the Handle Assembly is attached by cables and folded over



**PUT OIL IN ENGINE BEFORE STARTING**

**PARTS BAG & LITERATURE ASSY**

Warranty card P/N- 400972, Owner's Manual P/N-891203, General Safety and Warnings Manual- 100294, Declaration of Conformity P/N-891057, Ty-Wraps 900407 (qty2).

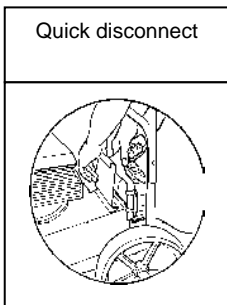
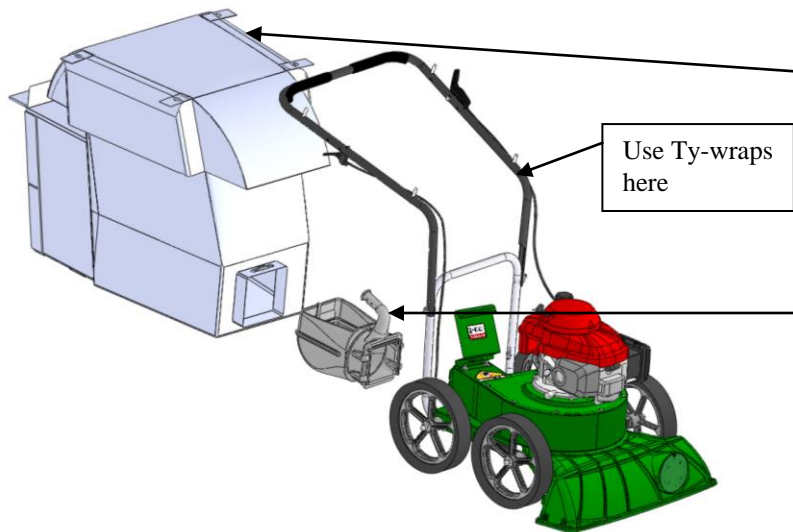

Fig. 2



- Boxing Parts Checklist**
- Debris Bag P/N-891132  
OR  
Felt Bag P/N-891126
  - Literature Assy P/N-891123
  - Connector Quick Disconnect P/N-890630
  - Honda 6.5 GSV 190
  - Briggs & Stratton 6.0 HP Quantum

**KV push hardware**

<p>36 Washer 1/4 SAE 8172007 qty. 2</p> <p>32 Washer 5/16 FLAT 8171003 qty. 4</p>	<p>29 Nut Acorn High Crown 840071 qty. 1</p> <p>34 Nut Lock 5/16-18 8160002 qty. 2</p>	<p>39 Screwcap 1/4-20 X 2" HCS ZP 8041010 qty. 1</p> <p>33 Screwcap 5/16-18 X 1 3/4" GR 5 HCS ZP 8041031 qty. 2</p>
---	--	---

**ASSEMBLY**

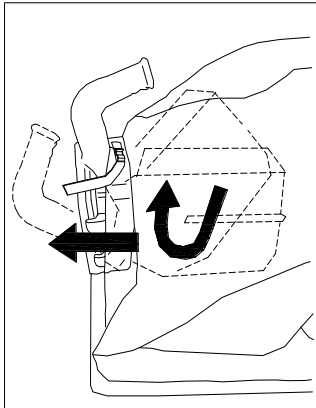
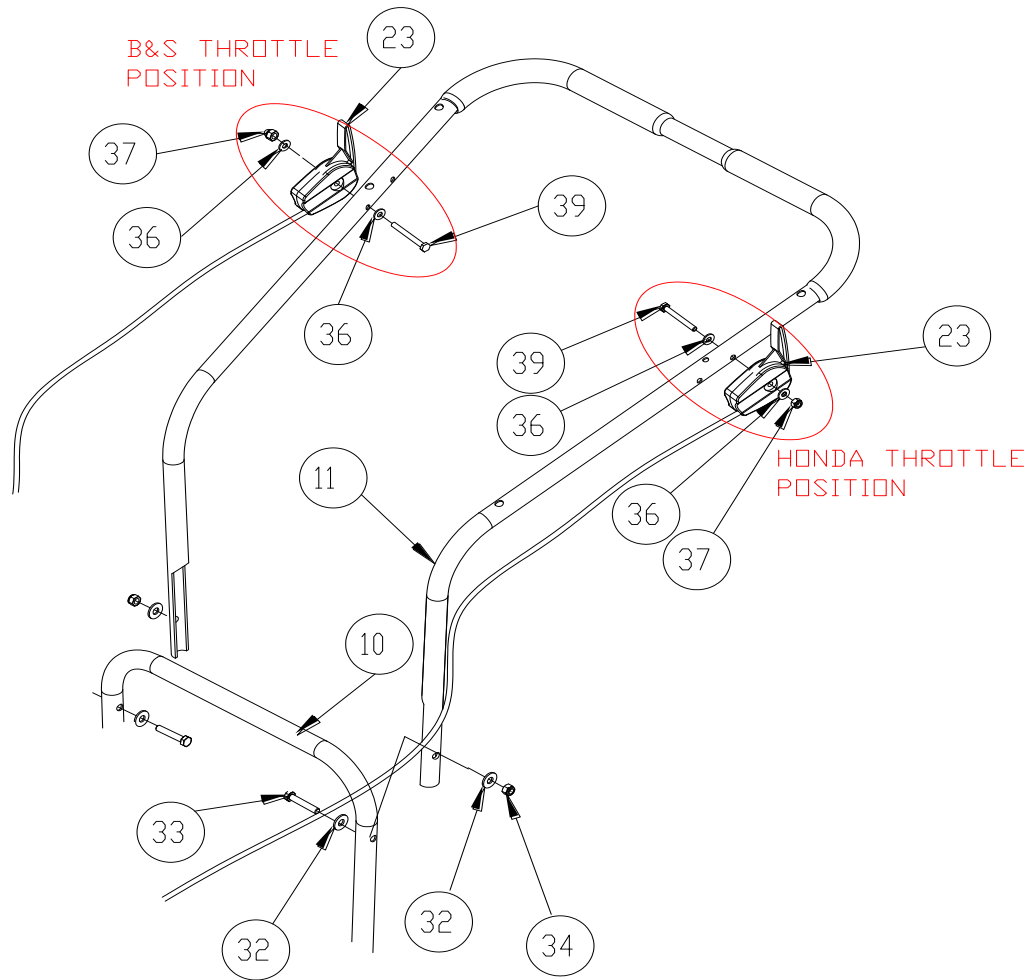

1. **ASSEMBLE** Lift upper handle (item 11), remove items 34, 32, and 33 The parts bag. Attach and secure upper handle as shown using same hardware.
2. **ATTACH** the throttle lever (item 23) to the handle either the right side or left depending on which model of engine you have (See image above). Attach the lever with the hardware (items 36, 37, and 39) found in the parts bag. Once attached use the ty-wrap to secure the cable to the handle
3. **UNFOLD** the debris bag (item 21) and fasten bag neck to bag quick disconnect (item 12). Attach firmly to housing exhaust (item 1) see fig. 2.
4. **ATTACH** bag hanger strap to bag supports (item 13), preassembled to upper handle.
5. **CONNECT** spark plug wire.

Insert the quick disconnect from the inside of the bag, tilt the handle so it can be fed through first. Then slide the connecting end through and tighten the strap





**OPERATION**

**VACUUMING OPERATION**

**VACUUM NOZZLE HEIGHT ADJUSTMENT:** Nozzle height is raised and lowered by rotating the red knob near the left rear wheel. Nozzle height should be adjusted based on the task being performed.

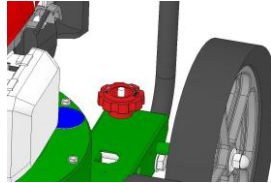

**FOR MAXIMUM PICKUP:** Adjust nozzle close to debris, but without blocking airflow into the nozzle. **NOTE:** Never bury nozzle into debris.

**CLEARING A CLOGGED NOZZLE & EXHAUST:** Turn engine off and wait for impeller to stop completely and disconnect spark plug wire. Wearing durable gloves, remove clog. **DANGER** the clog may contain sharp materials. Reconnect spark plug wire.



**BAG ENCLOSURE INSTRUCTION:**

NOTE: IT IS IDEAL TO DO THIS PROCEDURE WITH THE BAG ON THE GROUND WITH BOTTOM PAD FACING UP.

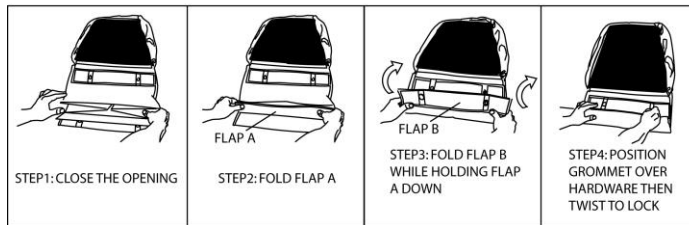

**DEBRIS BAG**

**Debris bags are normal replaceable wear items.**

**Note:** Frequently empty debris to prevent bag overloading with more weight than you can lift.

An optional felt bag is available for use where debris will be vacuumed in dusty conditions (see **Optional Accessories shown on page 1**).

**DO NOT** place bag on or near hot surface, such as engine. Be sure engine has come to a complete stop before removing or emptying bag.

**This vacuum is designed for picking up trash, organic material and other similar debris** (see Safety and General Operation manual).

However, many vacuums are used where dust is mixed with trash. Your unit can intermittently vacuum in dusty areas. Dust is the greatest cause of lost vacuum performance. However, following these rules will help maintain your machine's ability to vacuum in dusty conditions:

- Run machine at idle to quarter throttle.
- The debris bag must be cleaned frequently. A vacuum with a clean, pillow soft bag will have good pickup performance. One with a dirty, tight bag will have poor pickup performance. If dirty, empty debris and vigorously shake bag free of dust.
- Pressure-wash debris bag if normal cleaning does not fully clean bag. Bag should be thoroughly dry before use.

**NOTE:** Having one or more spare debris bags is a good way to reduce down time while dirty bags are being cleaned.

**DO NOT** leave debris in bag while in storage.

**COMPOST**

Vacuumed leaves, grass and other organic material from your own yard can be emptied into a pile or composter to provide enriched soil for later use as fertilizer in gardens and flower beds

**NOTE:** Allow green chips to dry before spreading around living plants.



**MAINTENANCE**

**PERIODIC MAINTENANCE**

Periodic maintenance should be performed at the following intervals:

Maintenance Operation	Every Use (daily)	Every 5 hrs (daily)	Every 25 Hours
Inspect for loose, worn or damaged parts.		•	
Clean Debris bag	•		
Check bag strap tightness	•		
Engine (See Engine Manual)			
Check for excessive vibration		•	

**IMPELLER REMOVAL**

1. Wait for engine to cool and disconnect spark plug.
2. Drain fuel and oil from the engine.
3. Remove bag, quick release, and upper handle. Do not kink, stretch, or break control cables, control housings, or end fittings while removing handles.
4. Remove housing top plate by removing bolts around outside of housing.
5. Leaving engine fastened to top plate, turn it upside down so the impeller is on top.
6. Remove impeller bolt and lock washer and washer.
7. Lift impeller upward. If impeller slides freely, proceed to (step 10).
8. Place two crowbars between impeller and housing on opposite sides. Pry impeller away from engine until it loosens. Using a penetrating oil can help loosen a stuck impeller.
9. If the impeller does not loosen, use two pry bars and pull the impeller near the hub away from the engine, this should loosen it and allow you to remove the impeller from shaft. *Using a penetrating oil can help loosen a stuck impeller.*
10. Using a new impeller bolt and lockwasher and washer, reinstall new impeller in reverse order.
11. Tighten impeller bolt. Torque impeller bolt to 33-38 Ft. Lbs. (44-51 N.m) (see item 30 on page 15).
12. Reinstall engine onto housing in reverse order of removal.
13. Gas and oil.
14. Reinstall spark plug wire.

**Troubleshooting**

Problem	Possible Cause	Solution
Abnormal vibration.	• Loose or out of balance impeller or loose engine	• Check impeller and replace if required. Check engine
Will not vacuum or has poor vacuum performance	• dirty debris bag. Hose kit cap missing. • Clogged nozzle or exhaust. Excessive quantity of debris. • Improper nozzle height	• Clean debris bag. Shake bag clean or wash. Check for hose kit cap. Unclog nozzle or exhaust. Allow air to feed with debris
Engine will not start.	• Stop switch off. Throttle in off position. Engine not in full choke position. Out of gasoline. Bad or old gasoline. Sparkplug wire disconnected. Dirty air cleaner	• Check stop switches, throttle, choke position and gasoline. Connect spark plug wire. Clean or replace air filter. Or contact a qualified service person.
Engine is locked, will not pull over.	• Debris locked in impeller. Engine problem.	• See page 5. Contact a engine service dealer for engine problems
Nozzle scrapes ground in lowest height setting.	Nozzle height out of adjustment	Adjust nozzle height (See Nozzle height fine adjustment for hard surfaces on page 5
Too much dust coming from bag.	• Vacuuming very dry, brittle or small debris	• Switch to felt bag (see page 1 accessories)



**PARTS DRAWING KV**

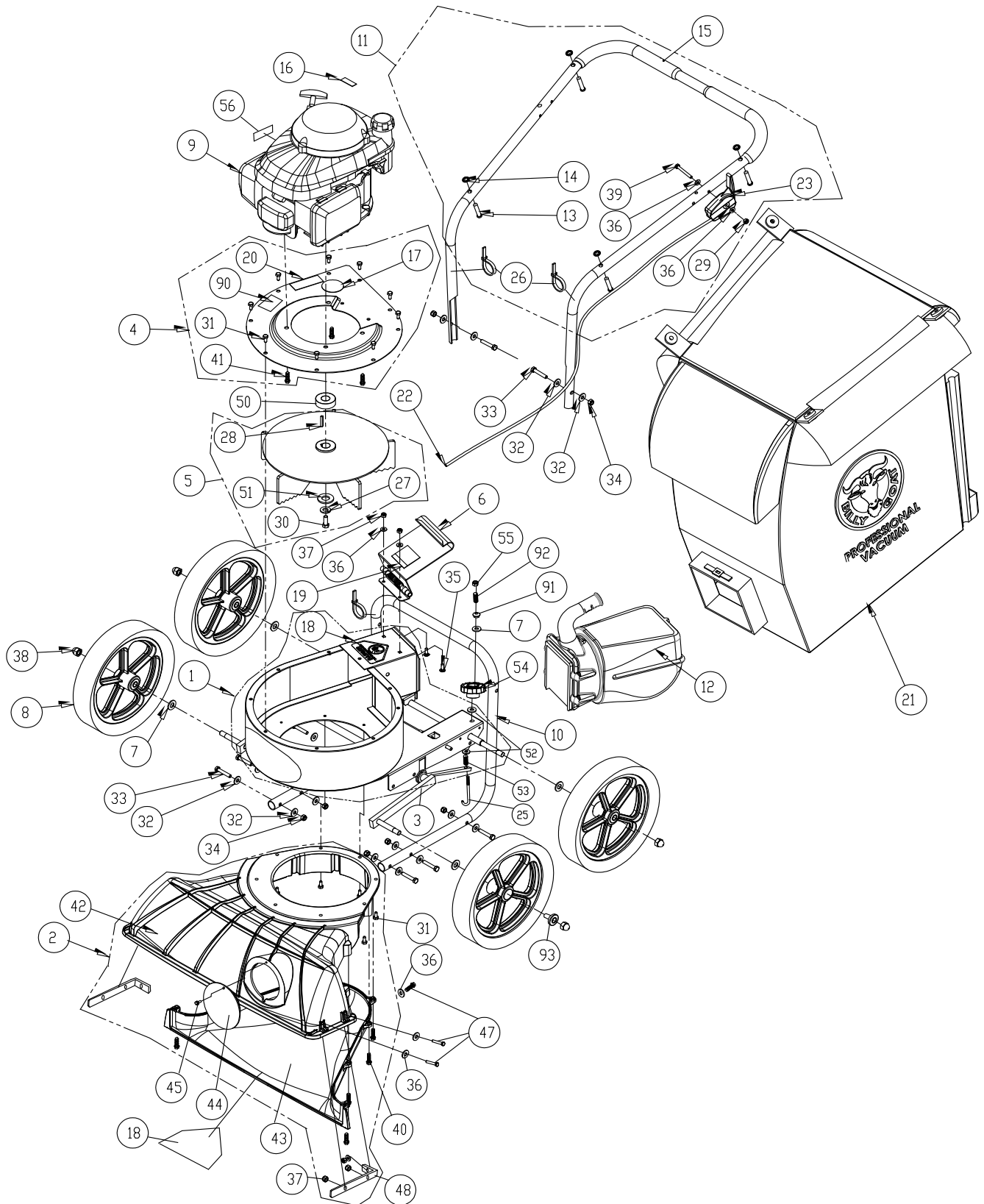



## KV Push Owner's Manual

### PARTS LIST

ITEM NO.	DESCRIPTION	KV600/KV600FB		KV650H/KV650HFB	
		PART NUMBER	QTY	PART NUMBER	QTY
1	MAIN FRAME HOUSING NEW KD	891100-S	1	891100-S	1
2	NOZZLE ASSEMBLY TKV	891110-S	1	891110-S	1
3	AXLE W/A KV MICRO	891138	1	891138	1
4	PLATE TOP ENGINE KV	891007-1-S	1	891007-1-S	1
5	IMPELLER 12.75 W/A PUSH VAC	891108-S	1	891108-S	1
6	DOOR EXHAUST ASSY RAW	890148	1	890148	1
7	WASHER 1/2" SAE Z/P	8172011	5	8172011	5
8	WHEEL ASSY 12" X 2.5" TREAD	900509	4	900509	4
9	ENGINE 6.5 HP HONDA GSV190AN1L	-	-	840069	1
	ENGINE 6.0 HP B&S	890622	1	-	-
10	LOWER HANDLE KV	891050	1	891050	1
11	HANDLE UPPER KV	891054-S	1	891054-S	1
12	QUICK DISCONNECT	890630	1	890630	1
13	PIN CLEVIS 3/8" x 2.125" LONG	520120	4	520120	4
14	RETAINER	360279	4	360279	4
15	GRIP HANDLE 1" X 9.5" LG	430342	2	430342	2
16	LABEL WARNING FUEL EN/SP	100261	1	-	-
17	LABEL READ	890301	1	890301	1
18	LABEL WARNING DANGER	400424	2	400424	2
19	LABEL DANGER FLYING DEBRIS	810736	1	810736	1
20	LABEL EAR EYE BREATHING	890254	1	890254	1
21	BAG DEBRIS NO ZIPPER KV	891132	1	891132	1
	BAG FELT W/SKIRT (FB MODELS)	891211	1	891211	1
23	CABLE THROTTLE ASSY 42" W/CHOKE	891036	1	891027	1
25	BOLT J 3/8-16 X 6"	891071	1	891071	1
26	TY WRAP	900407	3	900407	3
27	WASHER LOCK 3/8" ST MED	8177012	1	8177012	1
28	KEY 3/16 SQ. X 1.25	9201080	1	9201080	1
29	NUT 1/4-20 ACORN	840071	1	840071	1
30	SCREW CAP 3/8-24X1 LOCKTITE	900154	1	-	-
	SCREW CAP 3/8-24X1 1/2" GR. 8	-	-	900344	1
31	SCREW CAP 1/4 - 20 x 5/8 HWH	890359	16	890359	16
32	WASHER 5/16 FLATW ASHER Z/P	8171003	16	8171003	16
33	SCREW CAP 5/16-18 X 1.75 ZP	8041031	8	8041031	8
34	NUT LOCK 5/16-18	8160002	8	8160002	8
35	SCREW CAP 1/4-20 X 3/4"	8041004	2	8041004	2
36	WASHER 1/4" SAE ZP	8172007	10	8172007	10
37	NYLON INSERT LOCKNUT, 1/4-20 UNC	8160001	8	8160001	8
38	1/2-13 CAP NUT NP W/PATCH	890530	4	890530	4
39	SCREW CAP 1/4-20x2" HCS ZP	8041010	1	8041010	1
40	SCREW PLASTIC 1/4-10 X 1	891039	8	891039	8
41	SCREW 3/8 x 1 1/2 TAPTITE	890408	3	890408	3
42	NOZZLE TOP HALF KV	891002	1	891002	1
43	NOZZLE BOTTOM HALF KV	891003	1	891003	1
44	PLUG HOUSING KD LB	900146-01	1	900146-01	1
45	SCREW SELF TAPPING 10-24 X 1/2	891043	1	891043	1
46	LABEL KV PUSH	891045	1	891045	1
47	SCREWCAP 1/4-20 X 1"	8041006	6	8041006	6
48	BRACKET NOZZLE KV	891208	2	891208	2
49					
50	SPACER 1.5 OD X .875 ID X .975 THK	-	-	890616	1
51	WASHER 1.5 OD X .453 ID X .25 THK	440153	1	440153	1
52	WASHER 1/2" FC	8171006	2	8171006	2
53	SPRING COMPRESSION	891072	1	891072	1
54	KNOB 3/8-16 RED	891070	1	891070	1
55	NUT LOCK 3/8-16 THIN	8161042	1	8161042	1
56	LABEL SPARK ARRESTOR EN/SP	-	-	100252	1
57					
90	LABEL MADE IN U.S.A.	520116	1	520116	1
91	GROMMET FLANGE 1/2" MOLDED	830176	1	830176	1
92	SPRING COMPRESSION	400332	1	400332	1
93	BEARING BALL FLANGED	900774	4	900774	4